



Follow the instructions in this manual. Videos are available online to help your during assembly at RideWeehoo.com

<p>Attention: Cautions and Warnings</p>	<p>Attention</p>	<p>Sicherheitsregeln und Warnungen</p>
<ul style="list-style-type: none"> Follow these warnings. Failure to follow these warnings could result in injury to the Weehoo passenger or bicycle rider. Never leave the passenger unattended in the Weehoo. Passenger should be at least 2 years old and 36 inches tall. Do not roll the Weehoo in reverse with a child onboard. Passenger must wear a helmet and protective eyewear. Fasten the passenger's seat harness and foot straps. Allow for increased stopping distance. Do not exceed 15 mph, 5 mph for sharper turns. Before rides, check for loose or damaged hardware and worn parts. Install the Weehoo onto round, strong alloy or steel seat posts. Install the hitch at the bottom of seat post, resting on the seat collar. Do not ride at night. Observe and obey all local traffic laws for bicycles. Do not over-tighten quick releases or hardware. Ensure that parts on your bicycle, such as the seat quick release or fenders, do not interfere with the rotation of the Weehoo around the seat post. 	<ul style="list-style-type: none"> Il est extrêmement important que vous suiviez exactement les instructions de montage afin d'éviter le risque de blessure pour vous ou votre enfant. Ne jamais laisser le passager sans surveillance Le poids de votre passager et de votre baggage ne devrait pas dépasser 45kgs L'enfant doit avoir au moins 2 ans et 92 cm de hauteur Ne jamais reculer avec la remorque si l'enfant se trouve sur le bord L'enfant doit porter un casque et des lunettes de protection Les sangles doivent maintenir le corps de votre enfant dans le siège et ses pieds sur les pédales N'oubliez pas que le freinage est plus long hNe dépassez pas la vitesse de 24km/h (8km/h sur les détours) Vérifiez avant chaque utilisation que tout est bien en place et fonctionnel Fixer la Weehoo uniquement sur la tige de selle en acier ou en alliage Installez la fixation en bas de la tige de selle, reposant sur le collet de selle Ne conduisez pas pendant la nuit Observer et respecter toutes les lois locales de circulation pour les vélos Ne pas trop serrer les hélices et autres attaches rapides Assurez-vous qu'aucun objets ou pièces de votre vélo interfère avec votre remorque Weehoo. 	<ul style="list-style-type: none"> Bitte beachten Sie immer diese Regeln. Andernfalls könnte Ihr Kind oder auch Sie selbst verletzt werden. Lassen Sie Ihr Kind niemals unbeaufsichtigt im Weehoo. Ihr Kind sollte mindestens 2 Jahre alt und 90 Zentimeter groß sein. Schieben Sie das Weehoo nicht rückwärts, wenn ein Kind drinnen sitzt. Schützen Sie ihr Kind mit einem Helm und einer Schutzbrille. Schließen Sie den Sicherheitsgurt und die Fußriemen. Fahren Sie vorsichtig und rechnen Sie mit einem längeren Bremsweg. Fahren Sie nicht schneller als 25 km/h, 10 km/h in scharfen Kurven. Überprüfen Sie das Weehoo vor der Fahrt auf lose oder beschädigte sowie abgenutzte Teile. Verwenden Sie das Weehoo nur an einer runden, stabilen Sattelstütze aus Stahl oder einer Aluminiumlegierung. Montieren Sie die Kupplung so am unteren Ende der Sattelstütze, dass sie auf der Sattelrohrklemme aufliegt. Fahren Sie bei Dunkelheit nur mit ausreichender Beleuchtung. Beachten Sie alle Verkehrsregeln für Radfahrer. Ziehen Sie die Schnellspanner und Schrauben nicht zu fest an. Stellen Sie sicher, dass sich das Weehoo frei um die Sattelstütze bewegen kann und nicht an Teilen ihres Fahrrads wie Sattelschnellspanner, Schutzblech oder Gepäckträger streift.



Follow the instructions in this manual. Videos are available online to help your during assembly at RideWeehoo.com

Sicherheitsregeln und Warnungen	Atención: Precauciones y Advertencias	Aandacht: Voorzichtigheden en Waarschuwingen
<ul style="list-style-type: none"> • Bitte beachten Sie immer diese Regeln. Andernfalls könnte Ihr Kind oder auch Sie selbst verletzt werden. • Lassen Sie Ihr Kind niemals unbeaufsichtigt im Weehoo. • Ihr Kind sollte mindestens 2 Jahre alt und 90 Zentimeter groß sein. • Schieben Sie das Weehoo nicht rückwärts, wenn ein Kind drinnen sitzt. • Schützen Sie Ihr Kind mit einem Helm und einer Schutzbrille. • Schließen Sie den Sicherheitsgurt und die Fußriemen. • Fahren Sie vorsichtig und rechnen Sie mit einem längeren Bremsweg. • Fahren Sie nicht schneller als 25 km/h, 10 km/h in scharfen Kurven. • Überprüfen Sie das Weehoo vor der Fahrt auf lose oder beschädigte sowie abgenutzte Teile. • Verwenden Sie das Weehoo nur an einer runden, stabilen Sattelstütze aus Stahl oder einer Aluminiumlegierung. • Montieren Sie die Kupplung so am unteren Ende der Sattelstütze, dass sie auf der Sattelrohrklemme aufliegt. • Fahren Sie bei Dunkelheit nur mit ausreichender Beleuchtung. • Beachten Sie alle Verkehrsregeln für Radfahrer. • Ziehen Sie die Schnellspanner und Schrauben nicht zu fest an. • Stellen Sie sicher, dass sich das Weehoo frei um die Sattelstütze bewegen kann und nicht an Teilen ihres Fahrrads wie Sattelschnellspanner, Schutzblech oder Gepäckträger streift. 	<ul style="list-style-type: none"> • Siga estas advertencias. El incumplimiento de estas advertencias puede resultar en lesiones para el pasajero Weehoo o ciclista. • Nunca deje sin vigilancia el pasajero en el Weehoo. • Los pasajeros deben ser de al menos 2 años y 36 pulgadas de alto. • No gire la Weehoo a la inversa con un niño a bordo. • El pasajero debe llevar un casco, guantes y gafas de protección. • Fije el arnés del asiento del pasajero y correas para los pies. • Deje una mayor distancia de frenado. • No supere los 15 kilómetros por hora, 5 mph por curvas más cerradas. • Antes de paseos, compruebe piezas sueltas o dañadas y las piezas desgastadas. • Instale el Weehoo alrededor de una barra de sillín de acero o aluminio resistente. • Instale el gancho en la parte inferior de la barra del sillín, donde descansa el cuello del asiento. • No conduzca por la noche. • Observe y obedezca todas las leyes locales de tráfico para bicicletas. • No apriete demasiado las palancas de fijación rápida. • Asegúrese de que las piezas de la bicicleta, como la liberación rápida de seguridad o defensas, no interfieran con la rotación de la Weehoo alrededor de la barra del sillín. 	<ul style="list-style-type: none"> • Volgen kan leiden tot verwondingen van de Weehoo passagier of van de fietser. • Laat nooit de passagier zonder toezicht in de Weehoo. • Passagier moet minstens 2 jaar zijn en 36 inches of 92 cm groot zijn. • Rijd niet achterwaarts met de Weehoo als een kind erin zit. • Passagier moet een fietshelm en een fietshil dragen ter bescherming. • Bevestig altijd de veiligheidsgordels van de stoel en de voetenriempjes. • Houd rekening met een verhoogde afstand om te kunnen stoppen. • Overschrijd 22km/u niet, 7km/u voor scherpere bochten. • Kijk, voor elke rit, losse, beschadigde of versleten onderdelen na. • Installeer de Weehoo op ronde, sterk aluminium of stalen zadelpen. • Installeer de koppeling op het onderste deel van de zadelpen, rustend op de bovenzijde van de zadelpuis. • Rijd niet bij nacht of in het donker. • Ken alle locale verkeersregels voor fietsers en volg deze steeds op. • Overspan nooit de snelspanners (QRs) of andere onderdelen. • Verzeker U ervan dat onderdelen op uw fiets, zoals de snelspanner van het zadel of spatborden, niet kunnen interfereren met de draabewegingen van de Weehoo rond de zadelpen.

Follow the instructions in this manual. Videos are available online to help your during assembly at RideWeeahoo.com

Tools required:
Small adjustable wrench
4mm hex key



Lay out your components.



Insert back rest into fabric seat.

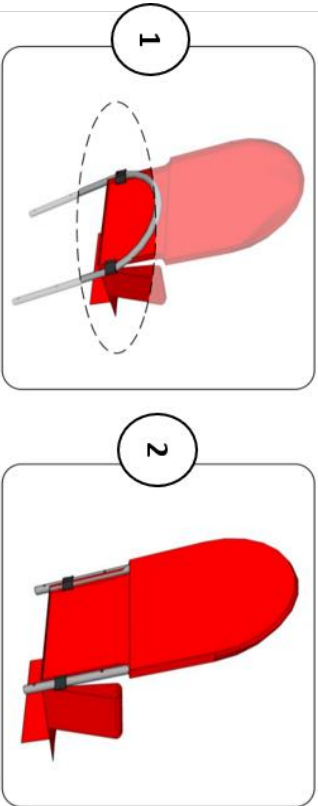

Install the arm rests to the seat base. Insert the armrests through the fabric sleeves. Secure the hook and loop closure.

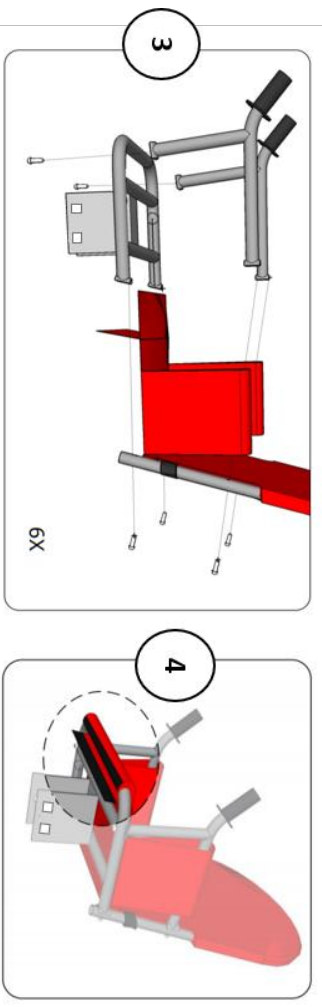

Using the adjustable wrench, install the pedals.



! Caution !

The pedals are marked **RIGHT** and **LEFT**.
The left pedal is reverse threaded.

Follow the instructions in this manual. Videos are available online to help your during assembly at RideWeeahoo.com

Install the push bar onto the frame, aligning the holes of the inner and outer tubes. Install and fasten the quick release pin. Install the fender using the hook and loop strap.

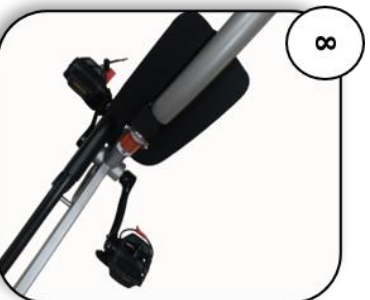

Install the safety flag. The flag holder is on the left side of the back wheel.

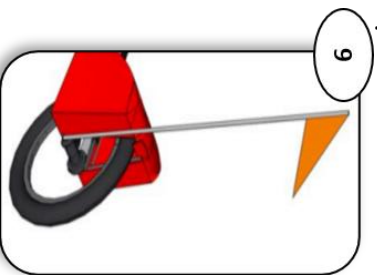

Install the reflector with the bushing included around the frame on top of the back wheel.



Install 2 seat bases onto the frame. The seat base is easiest to install if you close the bottom together using pliers, or a strong hand, while tightening the knob. You may also use pliers on the knob to help tighten. Continue tightening until there is little to no movement on the frame.

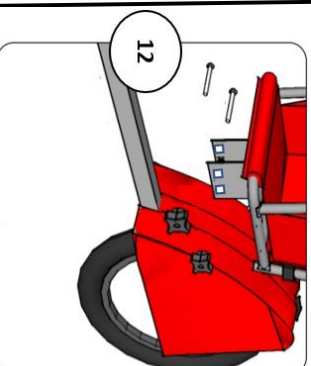

You may also use pliers on the knob to help tighten. Continue tightening until there is little to no movement on the frame.

Install the footrest onto the frame (between two seats). Insert the bolt then tighten it firmly.



Adjust the seats and footrest forward or backward to fit your child's leg length.

! Caution !

Never roll the bike trailer in reverse or you may trap your child's foot between the seat and the pedals.

Follow the instructions in this manual. Videos are available online to help your during assembly at RideWeeahoo.com

Take off your bike seat.

From the plastic bushing sets, select the bushing that fits your seat post precisely. Your seat post and the bushings are marked with a specific size. If the bushing is difficult to insert into the hitch, you may cut the small plastic bridge to make the bushing more flexible. Use scissors to cut the bridge.

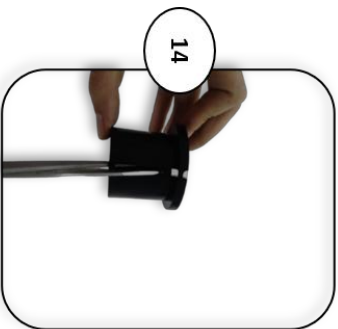
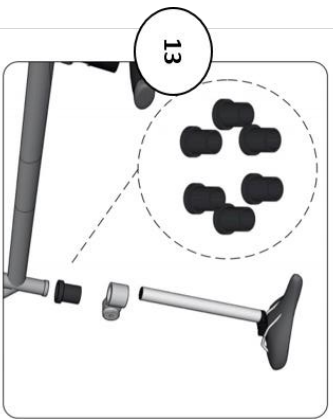

! Caution !

It is very important to have the correct bushing fit. Do not use with the incorrect bushing. Correctly installed, the bushing and hitch will prevent the trailer from wobbling and leaning.

The bushing must be installed as picture with the flange at the bottom of the hitch.

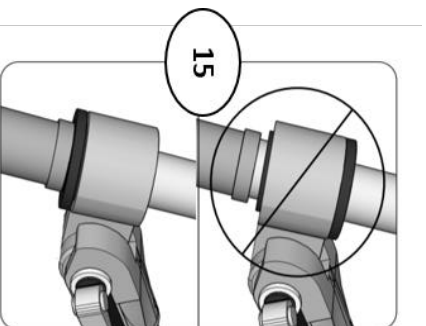

Insert the hitch around the bushing. Drop the receiver onto the hitch, then insert and secure the quick release pin.

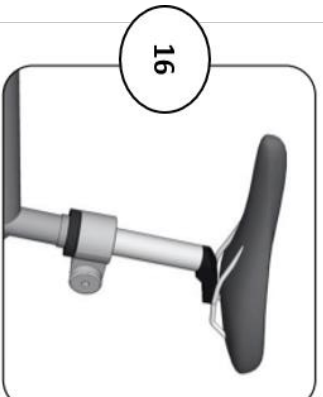

! Caution !

Do not use the trailer without the quick release pins installed.



Follow the instructions in this manual. Videos are available online to help your during assembly at RideWeeahoo.com

Until your child can load themselves, straddle the push bar to balance the bicycle and trailer while loading.



! Caution !

Riding in the seated position offers you the most stability and control. It is not recommended to stand and pedal while towing bike trailers.

Passenger and Cargo weight may not exceed 100 lbs / 45kgs

MAX 100 lbs / 45kgs

! WARNING

Follow the owner manual
Correctly connect to bicycle
Install fasteners correctly
Max total load: 100lbs/45kgs
Increases stopping distance
Do not ride after dark
Wear helmet and eye protection
No children unattended
Do not roll backwards
Recommended ages 2 to 9

Patented 7845664 & 8282117

www.RideWeeahoo.com

Weeahoo

Model: TWO V1000
Frame Color: Silver
Fabric Color: Red
SKU: 0730699390808

7 30699 39080 8