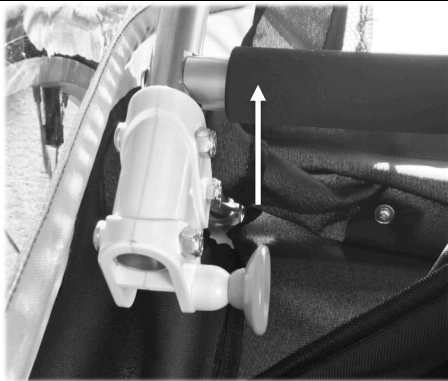

Visit www.RideWeehoo.com for additional instructions.

Warning

- Never leave children unattended in trailer.
 - Ensure adequate airflow in direct sunlight and warm temperatures. Trailer can become hot.
 - No more than two children in the trailer.
 - Passengers and cargo may not exceed 100 lbs.
 - Recommended minimum age is 2-years.
 - Passengers must wear helmet.
 - Passengers must be restrained by safety harness.
 - Allow for increased stopping distance.
 - Do not exceed 15mph; 5mph in corners.
 - Cornering at higher speeds may cause trailer to topple.
 - Inspect for loose hardware regularly.
 - Do not ride at night or in traffic.
 - Obey traffic laws.
 - Not intended for off-road use.
- Never leave children unattended in trailer.
 - On warm days, ensure the plastic rain flap open to ensure airflow and prevent overheating of passengers.
 - Check for adequate tire pressure regularly.
 - Do not use headphones while pulling trailer.
 - Do not attach to motorized device.
 - Install safety flag.
 - Do not pull trailer over large bumps or curbs.
 - Tipping hazards include:
 - Passengers leaning or bouncing
 - Cornering
 - Incorrect tire inflation
 - Uneven loading
 - Sudden steering

Follow these instructions to ensure safety.

Expand the trailer and lock the frame. Push the white elbow back towards the trailer to lock it into place.



To collapse the trailer, pull out on the red knobs and white elbows simultaneously.

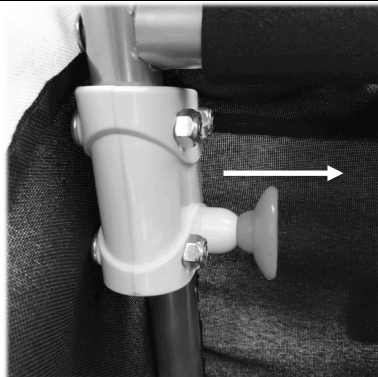

Adjust the safety harness to your passenger or passengers.

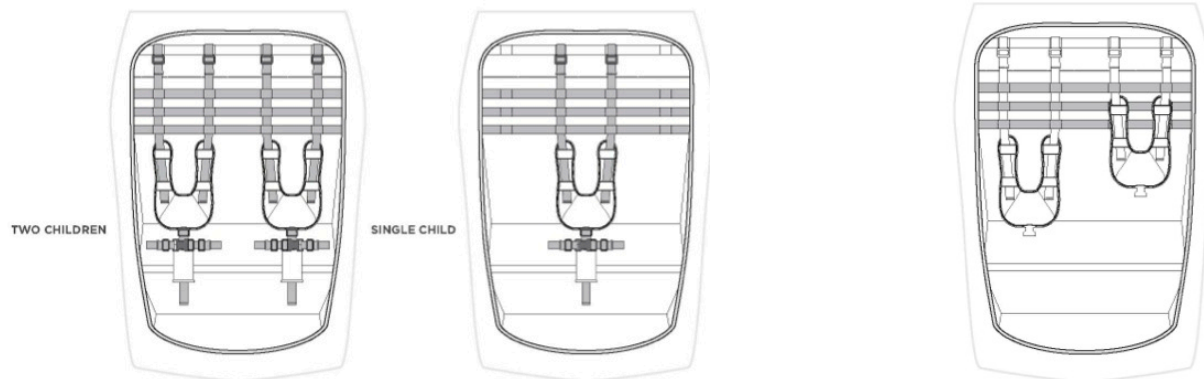

Install the wheels by depressing the rubber button in the center of the wheel, inserting the axle into the frame, then releasing the rubber button.

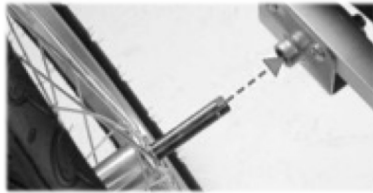

Pull in the wheel several times to ensure it is correctly engaged.

To apply the parking brake, use the red lever in the back of the trailer. Turn the lever to the left to engage the brake. Turn the lever to the right to release the brake.



When parking brake is engaged make sure the arm is fully inserted between the teeth of the wheel.



Installing the stroller wheels. Insert it into stroller wheel holsters. (The stroller wheels are for walking not jogging.)

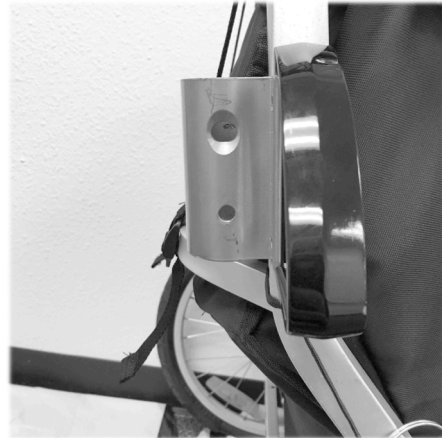

Press locking button and slide into the first hole.



Take the quick release pin and insert it into the back hole of the stroller wheel receiver. Push the wire lock over the pin.



Install the cover using the Velcro straps at the top and elastic loops at the bottom.



Installing bicycle tow attachment. Ensure spring button engages hole. Install and latch the pin into the second hole.



 Latch pin must be inserted through the bar and trailer.

Adjust the handle to the desired height by pressing the two red buttons.

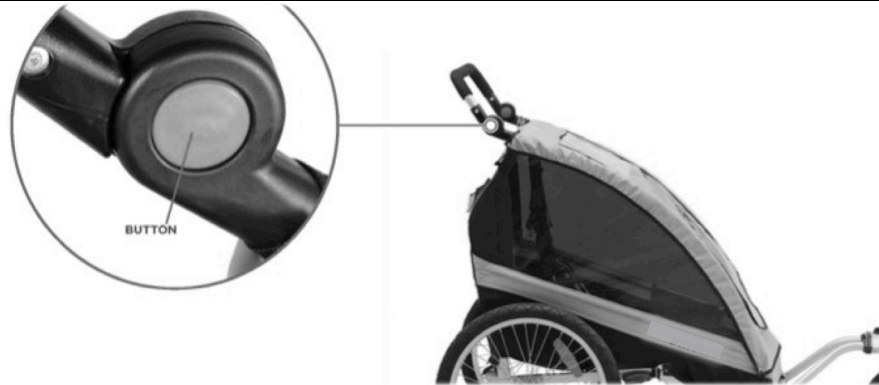

Attach the hitch to the bicycle. Then, connect the trailer using the latch pin and nylon strap.



 **Warning!** Ensure the safety loop is secured around the bicycle frame. Wrap the nylon loop around the frame enough times to ensure it does not hang loosely to become entangled in the bicycle wheel or brake. Install the pin and secure the latch.

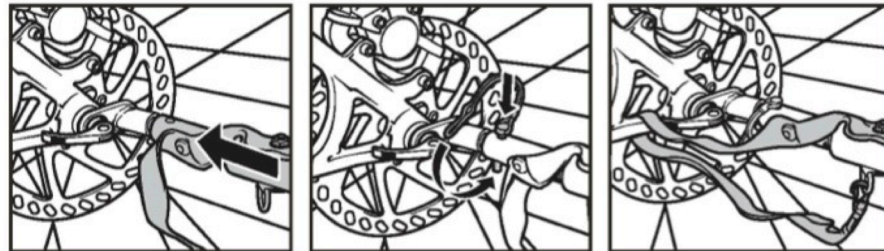

Install the safety flag.



If Equipped

To Install the jogger attachment. Ensure spring button engages hole. Install and latch the two pins into the second holes. Install the screws with the black plastic knobs.

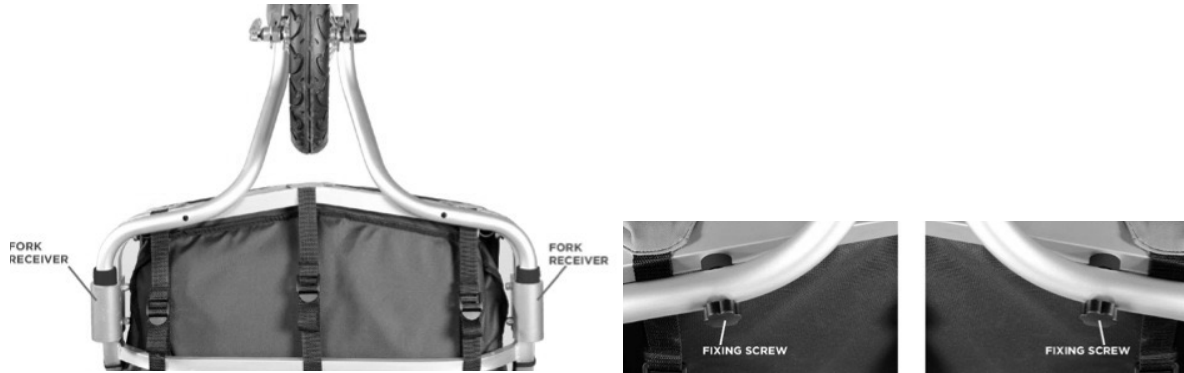

Assemble the stroller attachment using two bolts.



If the wheel is not vertical, loosen the screws, twist the assembly to align the wheel, then retighten the screws to hold the wheel in the desired alignment.

Adjust the stroller wheel lock or swivel setting.

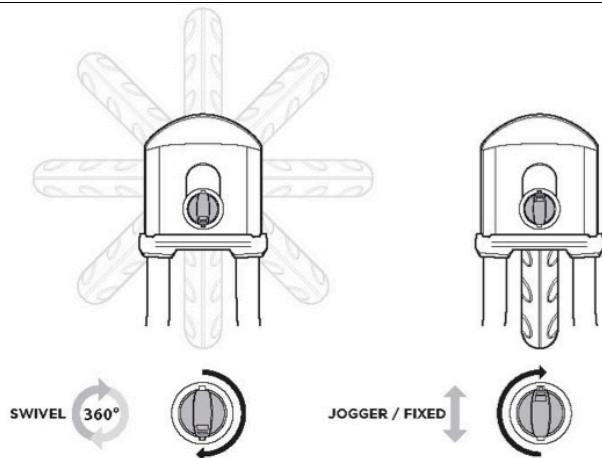

Weehoo®

www.RideWeehoo.com

Weehoo Wander 2018



info@WeehooGear.com

***Let The
Adventures
Begin!!!***